

Specifications: Model VT-313(60) NPT Valve

Vertical - Top In Flow

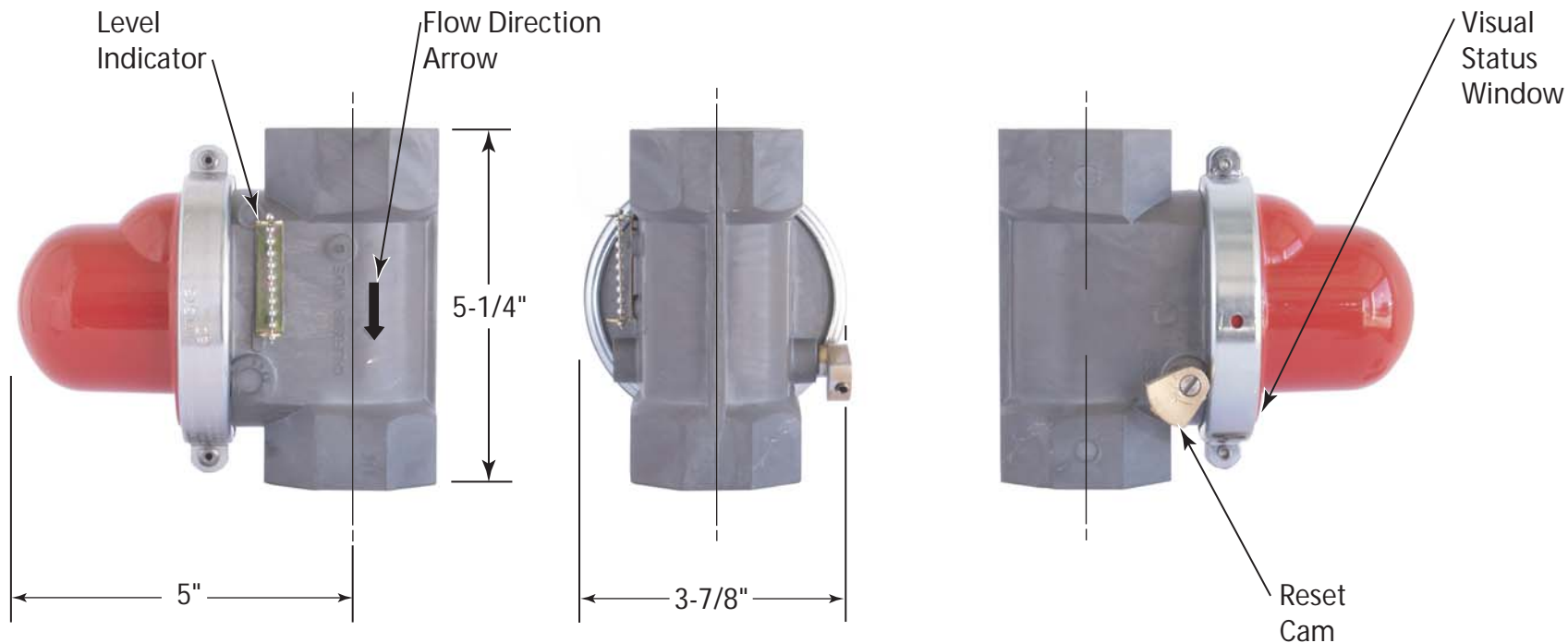

Valve Model#	CA-DSA No.	Length	Height	Width	Nominal Pipe Size	Threads Per Inch	APPLICATION	
							Max. Pressure	DATA Fuel
VT-313	60-04	5"	5-1/4"	3-7/8"	1-1/2"	11-1/2	60 psi	Dry Fuel Gas

California Seismic Valves are UL listed in the USA and Canada, Certified by the California State Architect's Office, Approved by the City of Los Angeles, and are warranted free of manufacturer's defects for 30 years. All valves meet California Standards for Earthquake Actuated Automatic Gas Shut off Systems, Standard No. 12-23-1, ANSI Z21.70, 1981 and ASCE 25-97 Standards.



**Alliance
International
Company, Inc.**

www.AllianceInternationalCo.com

Toll Free 866-422-8258

Tel 310-472-7592

Toll Free 866-776-8258

Fax 310-472-5276

